

Angles at a Point Worksheets

Calculate the value of x in the following figures:

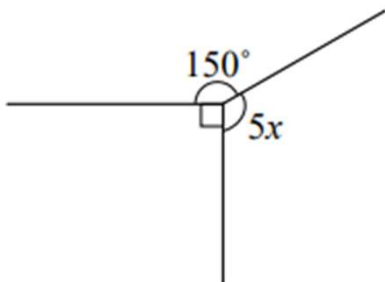
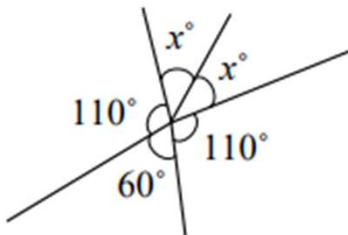
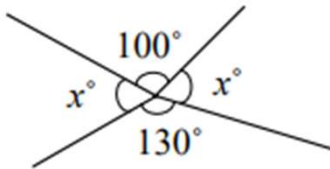
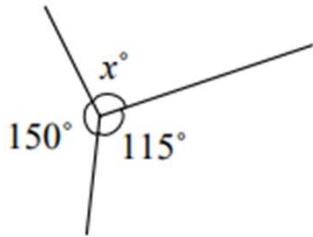

Go to [onlinemathlearning.com](https://www.onlinemathlearning.com) for more free math resources

Angles at a Point Worksheets

Calculate the value of x in the following figures:

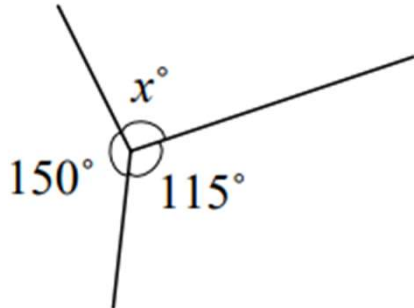

$$x = 95^\circ$$

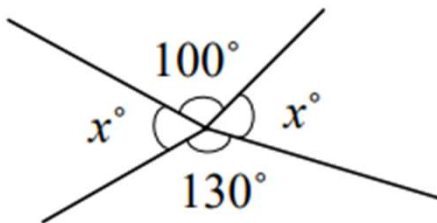

$$x = 65^\circ$$

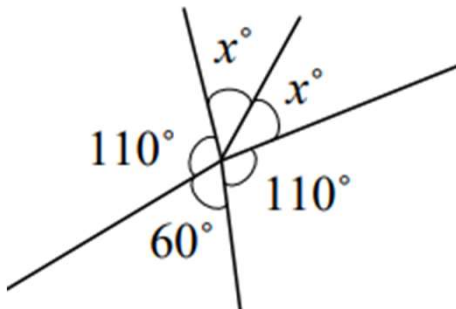

$$x = 40^\circ$$

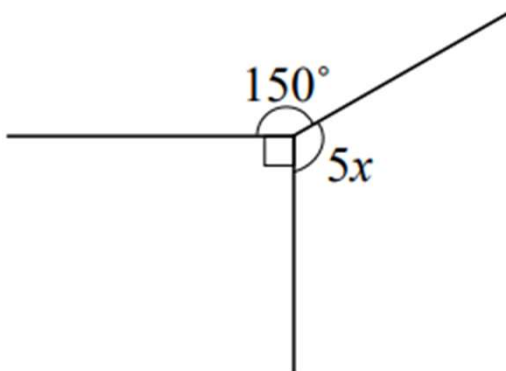

$$x = 24^\circ$$